



Tango LED Floodlight

BVP483 LED185 CW AWB PSU GR

The Philips Tango LED floodlighting provides a complete lighting solution for the most complex area of recreational & sports lighting applications. The floodlight comes with a single piece die cast aluminum housing with inbuilt potted driver & an external surge protection device. It reduces energy consumption, meets the highest performance standards, provides outstanding light quality, maintains uniformity and ensures safety and visual comfort. Tango LED offers a reduction in the total cost of ownership, has outstanding energy efficiency, is sleek & elegant in design, has dedicated optics for different applications such as Apron, ports and docks, and recreational sports facilities. Powered by LED technology, this luminaire delivers superior lighting performance and a longer lifetime, bringing area lighting to a whole new level. The floodlight is also compatible with other external control systems through DALI, 1-10V, and connected SR driver.

Warnings and Safety

- Meant for Outdoor Applications.

Product data

General Information		Optic type outdoor	
Beam angle of light source	55 °	Asymmetrical Wide Beam angle	55°
Light source color	857 daylight	Light source engine type	LED
Driver included	Yes	Operating and Electrical	
Optical cover/lens type	Polycarbonate	Input Voltage	120 to 277 V
Luminaire light beam spread	2° x 55°	Input Frequency	50 Hz
Control interface	Analog	Power Factor (Min)	0.95
Protection class IEC	Safety class I (I)	Controls and Dimming	
Flammability mark	F [For mounting on normally flammable surfaces]	Dimmable	Yes
Warranty period	2 years		
Material	Aluminum		

Tango LED Floodlight

Mechanical and Housing

Housing Material	Aluminum die-cast
Optic material	Polycarbonate
Optical cover/lens material	Polycarbonate
Mounting device	Via U Shaped Bracket, Aiming Scale Angle, Universal Installation
Color	Gray

Approval and Application

Ingress protection code	IP66 [Dust penetration-protected, jet-proof]
Mech. impact protection code	IK08 [5 J vandal-protected]
Surge Protection (Common/Differential)	Surge protection level until 4 kV

Initial Performance (IEC Compliant)

Initial luminous flux (system flux)	18500 lm
Initial LED luminaire efficacy	110 lm/W
Init. Corr. Color Temperature	5700 K
Init. Color Rendering Index	>70
Initial chromaticity	<5

Initial input power	155 W
Power consumption tolerance	+/-10%

Over Time Performance (IEC Compliant)

Median useful life L70B50	50000 h
---------------------------	---------

Application Conditions

Ambient temperature range	0 to +35 °C
---------------------------	-------------

Product Data

Order product name	BVP483 LED185 CW AWB PSU GR
Order code	919515813028
Numerator - Quantity Per Pack	1
Numerator - Packs per outer box	1
Material Nr. (12NC)	919515813028
Net Weight (Piece)	6.900 kg



Dimensional drawing

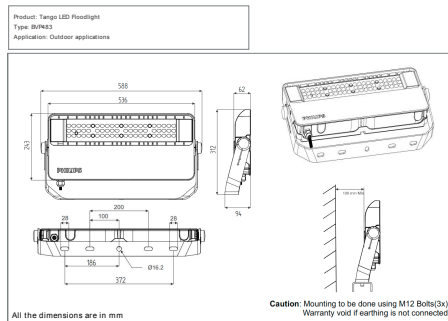

Outdoor Luminaires

