



# Strong performance spot light for retrofit MR16 halogen spots

## MASTER LEDspot LV

Delivering intense accent beam, MASTER LEDspot LV is an ideal retrofit solution for spot lighting. MASTER LEDspot LV is designed to replace halogen or incandescent spots. It realizes natural colors, enables cozy and comfortable ambience for residential, hospitality and emphasizes the beauty of merchandise in retail. New smaller housing provides perfect fitting with majority of luminaires in a market with a MR16 GU 5.3 holder. It not only employs Philips' patented solution to guarantee the broadest possible compatibility with standard 12V halogen electronic transformers, it also delivers high beam intensity which is equivalent to halogen MR16 spots. The dimming function enables to create the desired atmosphere and it works with broad selection of dimmers. Its high SDCM ensure stricter color consistency, that is maintained over product life. MASTER LEDspot LV delivers huge energy savings and minimizes maintenance cost without any compromise on light quality and lifetime, enabling residential and business owners to achieve a return on their investment within short period time.

### Benefits

- High intensity of beam for accent lighting in professional applications
- Strong brightness maintained over time
- More natural colors realised for cozy ambience for hospitality and better merchandise display in retail application

# MASTER LEDspot LV

## Features

- High intensity of beam equivalent to halogen spots
- Better color realisation with high CRI value, and strong color consistency over time
- Clearly defined beam spread for accent lighting
- Compatible with an extensive range of transformers and smooth dimming for dimmable products
- High lumen maintenance with long lifetime up to 40,000 hours

## Application

- Home: Living room, bed room, hall way
- Hospitality: Hotel guest room, corridors, lobby, reception area, restaurant, bars, cafes
- Retail: Exhibitions, display cabinets, shops, dressing room, check out area

## Dimensional drawing

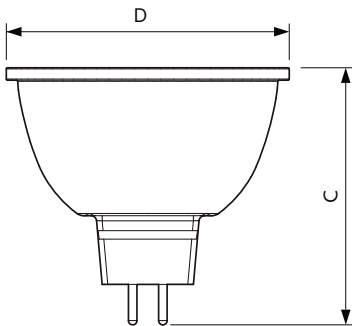

Product	D	C
MASTER LED 6.5-50W 927 MR16 36D Dim	50 mm	
MASTER LED 6.5-50W 930 MR16 24D Dim	50 mm	46.5 mm

General Information	
Cap-Base	GU5.3
Light Technical	
LLMF At End Of Nominal Lifetime (Nom)	70 %
Operating and Electrical	
Input Frequency	- Hz
Voltage (Nom)	ac electronic 12 V
Starting Time (Nom)	0.5 s
Temperature	
T-Case Maximum (Nom)	90 °C
Controls and Dimming	
Dimmable	Only with specific dimmers
Mechanical and Housing	
Bulb Shape	MR16

## Light Technical

Order Code	Full Product Name	Beam Angle (Nom)	Correlated Color Temperature (Nom)	Luminous Intensity (Nom)
929003072008	MASTER LED 6.5-50W 930 MR16 24D Dim	24 degree(s)	3000 K	2,800 cd
929003072208	MASTER LED 6.5-50W 927 MR16 36D Dim	36 degree(s)	2700 K	1,400 cd

# MASTER LEDspot LV

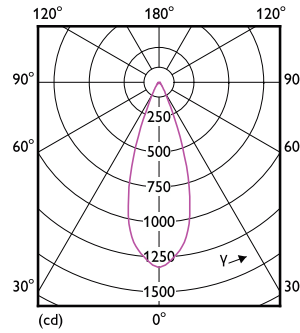
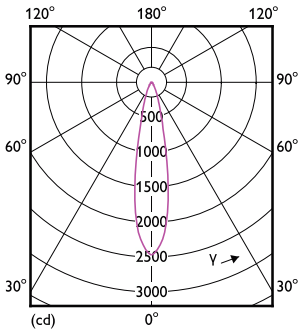

## Accent Diagrams

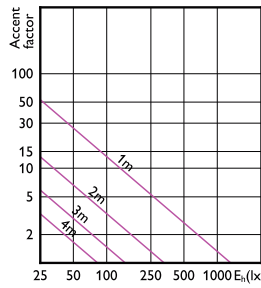
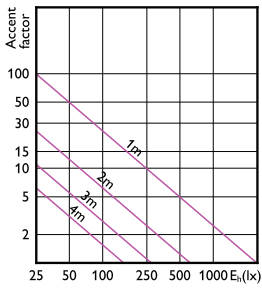

Accent Diagram - MASTER LED 6.5-50W 930  
MR16 24D Dim

Accent Diagram - MASTER LED 6.5-50W 927  
MR16 36D Dim

## Beam Diagrams

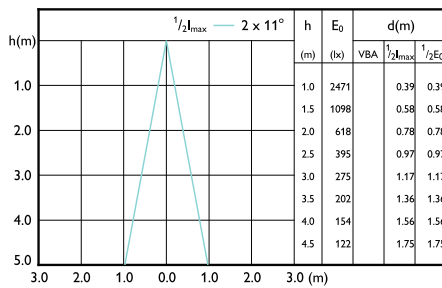
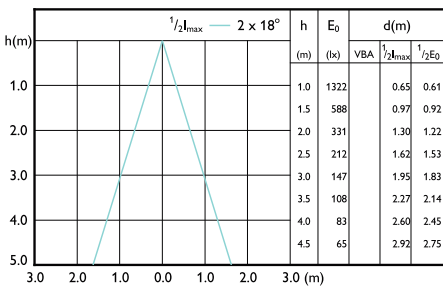

Beam diagram - MASTER LED 6.5-50W 927  
MR16 36D Dim

Beam diagram - MASTER LED 6.5-50W 930  
MR16 24D Dim

